

WITT Dome-loaded
Pressure Regulators
are engineered to
optimize performance
and value, for a wide
range of applications.

Made in Germany.
Made by WITT.

**“VALUE ENGINEERING”
IN PRESSURE REGULATION**

ZHENG ZHANG, SALES MANAGER WITT-GASESTECHNIK

PERFORMANCE AND ECONOMIC ADVANTAGES

WITT Dome-loaded Pressure Regulators – designed to meet your Value Engineering criteria.

› MAXIMUM ACCURACY AND STABILITY IN PRESSURE REGULATION

Even when flow rates and temperatures are changing, and when the inlet pressure is falling to within 14.5 psi (1 bar) of the required outlet pressure, WITT dome-loaded pressure regulators maintain control, improving the downstream process performance.

› ULTRA-LOW INSTALLATION AND MAINTENANCE REQUIREMENTS

WITT domes come fully assembled and tested, own-medium controlled, CE-marked, complete with gauges and built-in pilot pressure regulator, as a complete set, ready-to-go.

› SHORT LEAD TIMES AND WORLDWIDE SERVICE

Most standard WITT dome-loaded pressure regulators are available ex-works in less than 1 week. WITT's world-wide network of subsidiaries and partners provides the technical support.

Performance of WITT dome-loaded pressure regulators compared to three main competitors, measured with N₂. Example: WITT model 747LE/S

All WITT performance data validated by customers – details available on request.



WITT 747LE/S — competitors — — —

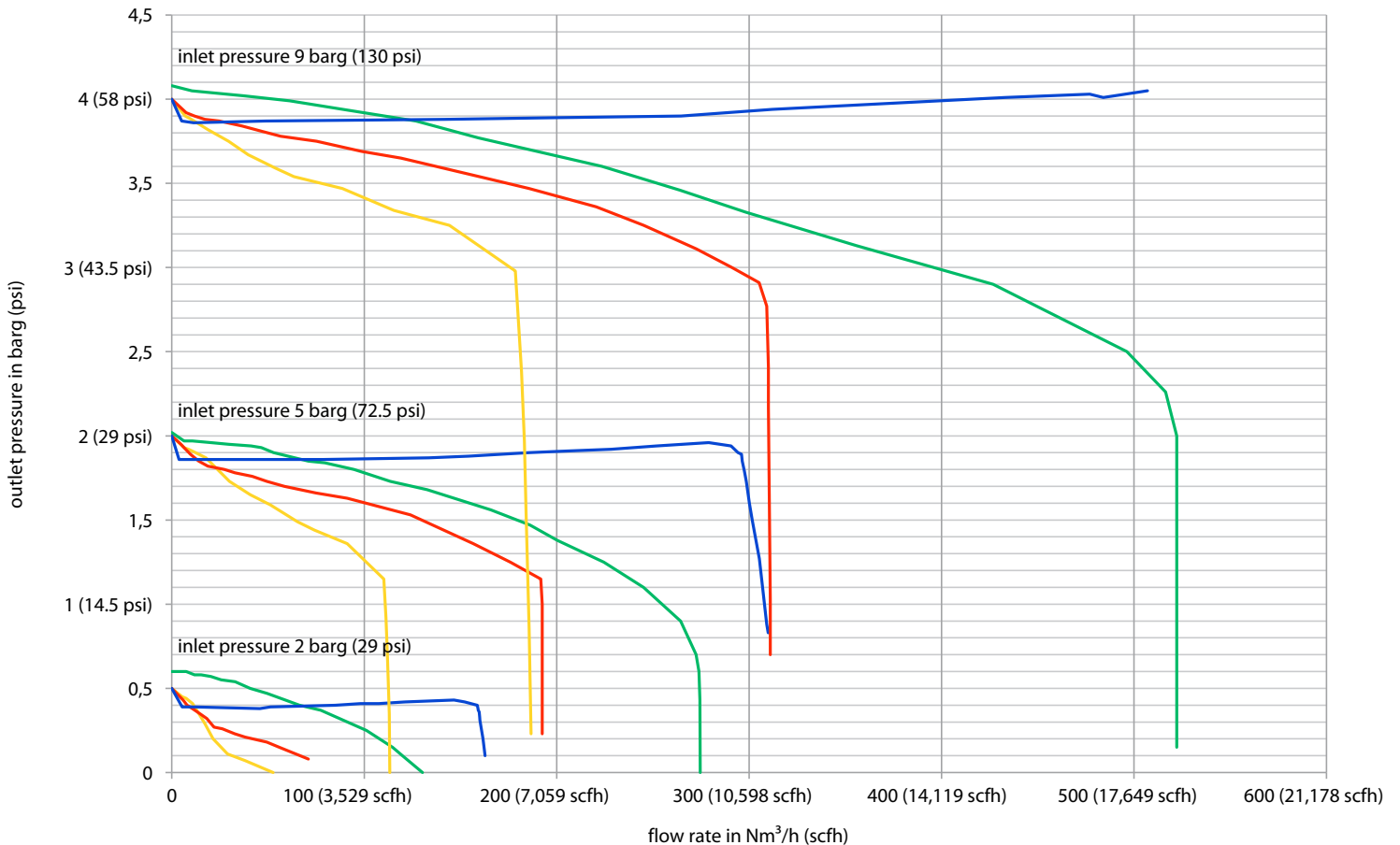

NOTE: full range of pressures and flows available – see next page. Other models available – see page 5.

APPLICATIONS

Areas of use, specific requirements, benefits.

EXAMPLES:

› CRYOGENIC TANK VAPORIZER OUTLETS

- A back-up supply to a 24/7 gas generator – the back-up will cut in at precisely the right pressure and will be seamless to the downstream process. This means 100 % availability. Can also be used for peak-shaving.
- Purge gases at high flow rates – at just under the downstream relief valve set-pressure
- Laser-assist gases – accurately delivered without always needing a 536 psi (37 barg) MAWP tank-rating

› CO₂ SYSTEMS FOR WELDING GASES

- All applications requiring accurate pressure control but with varying flow rates – see case study “Pressure stability improved our customers process” on page 7

› HIGH PRESSURE INDUSTRIAL GAS SUPPLIES, SUCH AS TUBE-TRAILERS, CYLINDER BUNDLES AND BUFFER TANKS

- Accurate control and high flow rates, even when the inlet pressure falls to within 14.5 psi (1 bar) above the outlet pressure – meaning more useable gas can be taken, thereby reducing replenishment/logistics costs
- Accurate outlet pressure control from PSAs and VSAs – smoothing out any pressure variations and improving the downstream process performance and safety

› PIPELINE GAS CONSUMPTION METERING

- Accurate pressure control meaning increased metering accuracy
- High flow with minimal ΔP

› BUILT INTO COMPRESSORS AND TURBINES

- Accurate outlet pressure control – smoothing out any pressure variations and improving the downstream process performance
- Seal-gases control – reducing friction, energy use and maintenance requirements



› WITT RANGE: PRESSURES – FLOWS – GASES – CONNECTIONS

- Our standard LE/S range is for O₂ from 435 psi (30 barg) and for N₂, Ar, He, H₂, CH₄ from 580 psi (40 barg) down to 7.2–435 psi (0.5–30 barg), up to 529,720 scfh (15,000 Nm³/h) (N₂), Kv values ranging from 2.4 to 30
- Our high pressure LE-HD/S range is for O₂, N₂, Ar, He, H₂, CH₄ from 4,351 psi (300 barg) down to 7.2–870 psi (0.5–60 barg), up to 84,755 scfh (2,400 Nm³/h), Kv value 1.65
- CO₂-specific versions are available (1,450 psi down to 7.2–377 psi /100 barg down to 0.5–26 barg)
- Standard gas temperature range -22°F to 122°F (-30°C to +50°C)
- Threaded and flanged connections from 3/4" up to 3" / DN100 – DIN or ANSI
- Customized versions are available, e.g. with proportional valves

Technical data sheets available at www.domepressure regulators.com

FUNCTION

A unique design for a unique performance.

Dome-loaded pressure regulators are operated with gas pressure. Unlike spring-loaded pressure controllers, the opening force of the valve required for pressure reduction is generated by the pressure of a so-called pilot gas and not by a spring. In the dome-loaded pressure regulator sets from WITT, the gas to be regulated is itself used as the pilot gas ("own-medium controlled"). The gas to be regulated is supplied to the dome where it reaches the valve seat. The pilot gas is controlled via a built-in pilot gas regulator and led into the pressure chamber. Here, it acts on a diaphragm whose stroke movement is transferred to the valve seat via a diaphragm plate. So the valve gets opened or closed via the pressure of the pilot gas and the relevant stroke movement of the diaphragm, dependent upon the chosen operating pressure, and the flow required. The excess pilot gas is routed to the outlet pressure side via an integrated non-return valve. Thus, WITT dome pressure regulator sets are closed systems and allow the outlet pressure to be adjusted whilst in service.

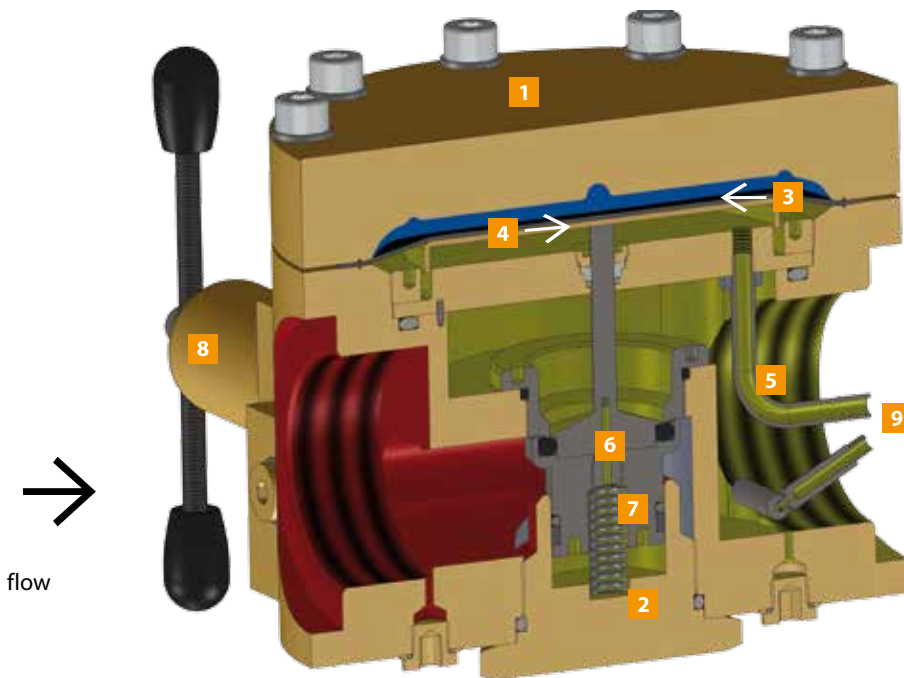

- 1 Body**
either in brass or in high-quality 1.4404 stainless steel
- 2 Valve seat**
- 3 Diaphragm**
A large diaphragm with a wide bearing surface on the diaphragm plate enables accurate regulation
- 4 Diaphragm plate**
- 5 Pilot Control Tube**
does not check the existing outlet pressure on the valve seat but at the output of the pressure regulator where it is relevant for receiving the correct outlet pressure
- 6 Balanced Seat Design**
Bore hole through the valve seat that leads the outlet pressure under the valve seat and thus balances it out
- 7 Closing spring**
- 8 Pilot Pressure Regulator**
- 9 Routing of the excess pilot gas**
to the outlet pressure side

■ Inlet pressure ■ Pilot pressure in pressure chamber ■ Outlet pressure

OUR MODELS

Overview.

› DIAPHRAGM

Unlike many other designs, the diaphragm of WITT products is not located directly on the valve seat. Instead, it transfers the stroke movement via a special diaphragm plate. This allows extremely fast adaptation to withdrawal changes. There are no fluctuations in the outlet pressure until the pressure controller finds the correct valve opening. The special diaphragm also enables an extremely wide regulation range. The pressure is accurately regulated even in case of small pressure differences of less than 14.5 psi (1 bar) in the inlet pressure and the outlet pressure. Large pressure differences can also be realized. A 2-stage pressure reduction is therefore not required.

› BALANCED SEAT DESIGN

A bore hole through the valve seat and a special sealing of the stroke movement balance out the valve from both sides on an even surface by back pressure. The inlet pressure does not act on the valve piston and the outlet pressure is almost independent of the inlet pressure fluctuations.

› PILOT CONTROL TUBE

Unlike other regulators, most of the WITT dome-loaded pressure regulators do not check the existing outlet pressure on the valve seat but at the output of the pressure regulator where it is relevant for the correct outlet pressure control. This allows highest precision in pressure regulation. (Model 737LE/S is without Pilot Control Tube)

› PILOT PRESSURE REGULATOR

A major advantage of most of the WITT dome-loaded pressure regulators is their easy and flexible use. The integrated pilot pressure regulator can be used to adjust the operating pressure as soon as a different gas pressure is required at the outlet point or the gas or ambient temperature changes significantly.

› CLOSED CONTROL SYSTEM

WITT dome-loaded pressure regulators are flexible regarding the gas supply. The regulated gas (internal medium) is used as pilot gas. Therefore, the dome-loaded pressure regulator works autonomously and the pilot gas is then supplied to the outlet pressure side once again. Gas is thus not used for pressure control and there are no additional costs.

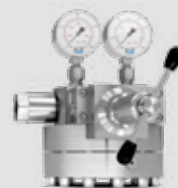
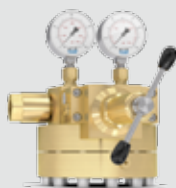

› **737LE/S-HD**
High Pressure
(4,351 psi / 300 bar)
Dome-loaded Pressure
Regulator Set
Kv value: 1.65/Cv value: 1.9
Inlet 3/4" F, incl. inlet filter,
outlet 1" F, G or NPT
Special CO₂ model
available

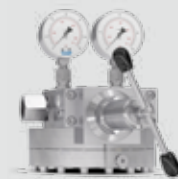
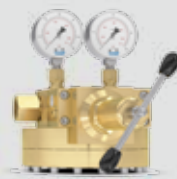

› **737LE/S**
Universal
Dome-loaded Pressure
Regulator Set
Kv value: 2.4/Cv value: 2.8
3/4" F, G or NPT
incl. inlet filter



› **747LE/S**
Universal
Dome-loaded Pressure
Regulator Set
Kv value: 3.6/Cv value: 4.2
1" F, G or NPT
DIN/ANSI flange

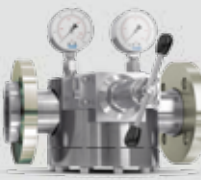
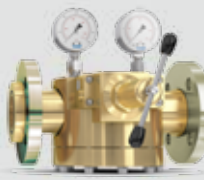

› **757LE/S**
High Performance
Dome-loaded Pressure
Regulator Set
Kv value: 15/Cv value: 17.4
2" F, G or NPT
DIN/ANSI flange

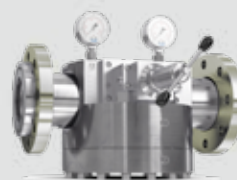
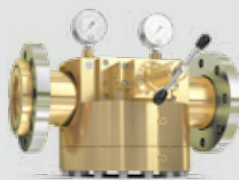

› **767LE/S**
High Performance
Dome-loaded Pressure
Regulator Set
Kv value: 30/Cv value: 34.8
3" F, G or NPT
DIN/ANSI flange

All models with ultra-low maintenance requirements

- Depending on the application, wetted moving parts may need to be replaced every 1–3 years
- Pre-assembled maintenance kits available from stock, ex-works

Technical data sheets available at www.domepressureregulators.com

PRACTICAL EXAMPLES

WITT Dome-loaded Pressure Regulators in industrial plants.

› AUTOMATED GAS SUPPLY TO FLAME CUTTING MACHINE

The 3 lines for oxygen and propane each go via a dome-loaded pressure regulator. The pilot control gas is regulated via proportional valves controlled by a PLC. Automatic adjustments of the pilot gas pressure regulate the flowrates into the burners, thereby controlling the cutting process.

The dome-loaded pressure regulators minimize any variations, and allow for optimal cutting, at a fraction of the price of a fully electronic control system.

.....



› NITROGEN SUPPLY SWITCH-OVER UNIT

The customer demanded a very high performance and reliable pressure control of a nitrogen supply for the packaging of potato snacks. To meet this challenge, WITT installed two supply lines in parallel, each with a dome-loaded pressure regulator set 767LE/S.

The gas is regulated from 174 psi (12 bar) down to 87 psi (6 bar). The dome-loaded pressure regulators function independently. To allow for maintenance, ball valves enable each dome to be isolated. This parallel arrangement gives 100 % up-time.

.....

› REDUNDANCY-CAPABLE PRESSURE CONTROL FOR VACUUM ANNEALING

The process required a constant 145 psi (10 bar) supply of nitrogen into the annealing furnace, from a 188 psi (13 bar) tank. The customer requested a parallel redundant system, plus a roof cover. The average gas flow per furnace should be around 5,297 scfh (150 m³/h), and 4 should be mounted, allowing up to 21,188 scfh (600 m³/h). To allow for major process upsets requiring emergency N₂ blanketing, a maximum flow rate of 56,503 scfh (1,600 m³/h) was set. Because the WITT dome sets are also able to regulate small flows precisely, a single redundancy capability was designed for using the WITT 757LE set.

.....



› CUSTOMIZED DOME SYSTEM FOR OXYGEN SUPPLY

This customized system, fully assembled in a lockable cabinet, controls the supply of oxygen into an industrial waste water treatment plant. The detailed specification to ensure a flow rate of some 35,314 scfh (1,000 m³/h), was drawn up by specialist WITT company Gustus & Partner GmbH in conjunction with the customer, including TÜV certification.

.....

› REDUNDANT PRESSURE REGULATING STATION DN100 FOR OXYGEN INERTING OF FLAME LANCES (STEEL INDUSTRY)

The customer required an electronic pressure control system, with redundancy, to deliver a minimum flow of 77,692 scfh (2,200 m³/h) at up to 203 psi (14 bar), from an inlet pressure of 217 psi (15 bar). This was achieved with one WITT dome pressure regulator 767LE (with proportional control) per line.

.....



WITT Dome Pressure Regulator HD for welding gas mixtures supply.



Manoj Niraj,
Project Manager
at Legris

› **LEGRIS: “PRESSURE STABILITY IMPROVED OUR CUSTOMER’S WELDING PROCESS”**

Legris India offers gas supply solutions, including gas storage and mixing systems. One such project is supplying welding gas mixtures to Indian Railways at Raebareli. CO₂ (from cylinders) and Argon (from a cryogenic tank) are supplied into WITT Gas Mixers.

Mr Manoj Niraj, Project Manager at Legris, describes the challenge: “We had problems during the commissioning of the system due to not enough CO₂ flow to the mixers through the old CO₂ regulator on the cylinder manifold. Our customer needs stable flow even in fluctuating demands from the mixers depending on the usage rates. And the regulator failed to provide constant pressure to the mixer with fluctuating flow. There was always a drop of pressure that activated the mixer input pressure alarms.”

He approached WITT with this problem and WITT’s Indian service team came out with a solution – a WITT dome-loaded pressure regulator 737LE-HD/S. This regulator is designed to deliver stable outlet pressure irrespective of flow fluctuations, and irrespective of changes in upstream pressures.

MR. NIRAJ’S CONCLUSION:

“With the WITT regulator, our customer has had trouble-free operation for almost a year, no production loss or downtime, with no stoppage of operation due to CO₂ supply failure, and no variation of outlet pressure with flow.”

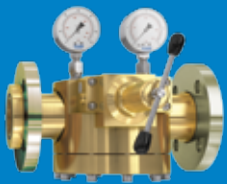

› **COMPLIANCE WITH ALL RELEVANT STANDARDS**

- WITT is certified to ISO 9001, ISO 22000 and PED 2014/68/EU module H
- All WITT Dome systems are CE-marked under supervision of TÜV (Germany’s Technical Inspection Association) and in accordance with PED 2014/68/EU
- ATEX 2014/34/EU certification also available, based on specific application, to EN 1127-1, DIN EN 13463-1 and ZH1/200
- Suitable for food applications, HACCP analysed
- Compliant with Regulation (EC) No. 1935/2004 and Regulation (EC) No. 2023/2006
- Meets requirements of German Food and Feed Code (LFGB)
- All materials in contact with O₂ are approved by German Federal Institute for Materials Research and Testing (BAM) per Code of Practice M034e (BGI 617e)
- The design of dome-loaded pressure regulators for oxygen over 1,450 psi (100 barg) has been subjected to Adiabatic Decompression testing by BAM per ISO 7291 clause 9.4.4

In addition,

- individual approvals for O₂ service have been granted by global industrial gas manufacturers (specific details available on request)

OUR PRODUCT RANGE

GAS CONTROL EQUIPMENT

- Gas mixing systems
- Gas metering systems
- Gas analysers
- Leak detection systems
- Gas pressure vessels
- Engineering of customized systems

GAS SAFETY EQUIPMENT

- Flashback arrestors
- Non-return valves / check valves
- Quick couplers
- Safety relief valves
- Stainless steel devices
- Gas filters
- Pressure regulators
- Outlet points
- Lance holders
- Ball valves
- Automatic hose reels
- Test equipment
- Accessories
- Customized safety equipment

WITT-Gasetechnik GmbH & Co KG

Salinger Feld 4-8
58454 Witten
Postfach 2550
58415 Witten
Deutschland
Tel. +49 (0)2302 8901-0
Fax +49 (0)2302 8901-3
www.wittgas.com
witt@wittgas.com

GUSTUS & PARTNER GmbH

Installation – Service – Wartung
Alt Salbke 6-10, Geb. 59
39122 Magdeburg
Deutschland
Tel. +49 (0)391 4015246
Fax +49 (0)391 4013296
gustus@wittgas.com

WITT Tecnología de Gas, S.L.

C/Simón Cabarga N° 2a – Bajo
39005 Santander
España
Tel. +34 942 835142
Fax +34 942 835143
witt-espana@wittgas.com

WITT FRANCE S.A.R.L.

131 Voie de Compiègne
91390 Morsang sur Orge
France
Tel. +33 (0)160 151779
Fax +33 (0)160 154782
witt-france@wittgas.com

WITT Gas Techniques Ltd.

Unit 7 Burtonwood Industrial Estate
Phipps Lane, Burtonwood
Warrington, Cheshire
WA5 4HX
Great Britain
Tel. +44 (0)1925 234466
Fax +44 (0)1925 230055
witt-uk@wittgas.com

WITT GAS INDIA PVT.LTD.

855/N, Upen Banerjee Road
Kolkata 700060
West Bengal
India
Tel. +91 9831319810
witt-india@wittgas.com

WITT ITALIA Srl.

Via Giovanni XXIII, 18
24030 Solza (BG)
Italia
Tel. +39 035 4933273
Fax +39 035 4948098
witt-italia@wittgas.com

WITT POLSKA Sp. z o. o.

ul. Legnicka 55/UA5
54-203 Wrocław
Polska
Tel. +48 (0)7135 22856
Fax +48 (0)7135 13113
witt-polska@wittgas.com

WITT Gas Controls LP

3080 Northfield Place
Suite 111
Roswell, GA 30076
USA
Tel. +1 770 664 4447
Fax +1 770 664 4448
witt-usa@wittgas.com

What are your requirements?

Please contact us.

Tel. +1 770 664 4447 | witt-usa@wittgas.com