

DECOMPOSITION ARRESTOR MGN

safety device



WITT Decomposition Arrestors for reliable protection against decomposition of acetylene up to 25 bar.
Every Arrestor 100% tested.

Benefits

- meets the requirements according to TRAC 207, clause 8.1 "Decomposition Arrestors in acetylene plants" and EN ISO 15615:2002, clause 6.4 "acetylene decomposition test".
 Conformity to the Code of practice (EIGA acetylene IGC Doc 123/04)
- single test from BAM
- protect from accidents during filling of acetylene gas cylinders
- a large surface area flame arrestor [FA] of stainless steel construction:
 - stop dangerous decomposition of acetylene both-sided or only from one-side depending on version (see table)
- a spring loaded non-return valve [NV] prevents slow or sudden reverse gas flow forming explosive mixtures in the gas supply (option)
 - opening pressure approx. 60 mbar

Operation / Usage

- as a Decomposition Arrestor for acetylene in high pressure pipe-lines for protection from filling equipment
- WITT Decomposition Arrestors may be mounted in any position / orientation
- the maximum ambient / working temperature is 70 °C / 158 °F

Maintenance

- it is recommended that an annual body leakage test is performed
- Decomposition Arrestors are only to be serviced by the manufacturer

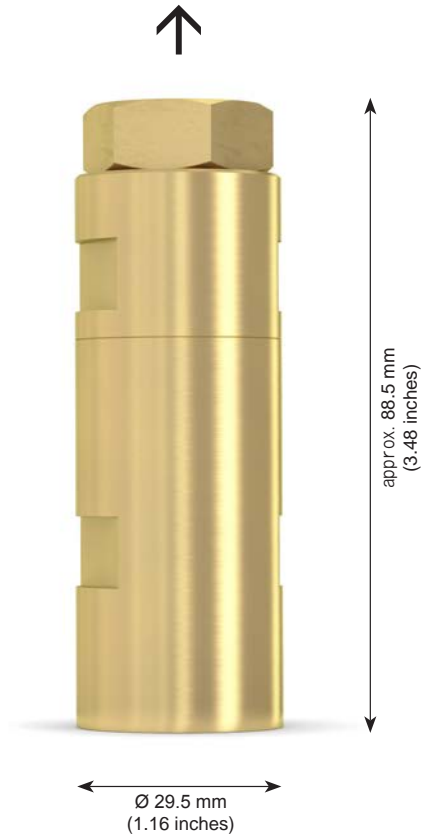

Example: Model 022-010

Approvals

Company certified according to ISO 9001 and PED 2014/68/EU Module H

Max. working pressure [bar]	Housing-Material	Seal-Material	FA	NV	Weight [g]	Connection [inch]	Connection [inch]	Order-No.	Decomposition stop	
									one side	both side
Acetylene (A) 25	Brass	EPDM	X	X	392	G 1/2 RH F	1/4" NPT F	022-010	X	-
			X	X	356	G 1/4 RH M with cone	G 1/4 F	022-011	X	-
			X	X	412	1/4" NPT F	1/4" NPT F	022-015	X	-
			X	-	385	G 1/2 RH M	W21.8x1/14 M	022-014	X	-
			X	-	392	5/8LH NEN 3268 Nr. 8	1/8" NPT F	022-002	X	-
			X	-	392	M24x1 M	1/4" NPT F	022-013	-	X

Other connections available upon request

DECOMPOSITION ARRESTOR MGN

safety device

022-010

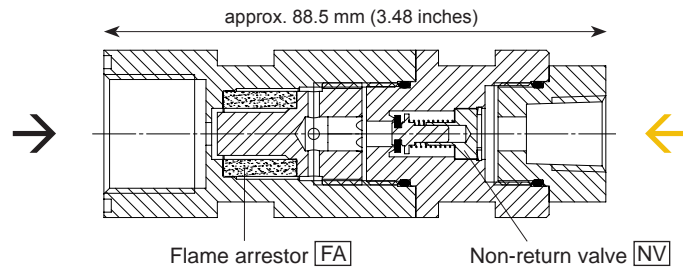

022-011

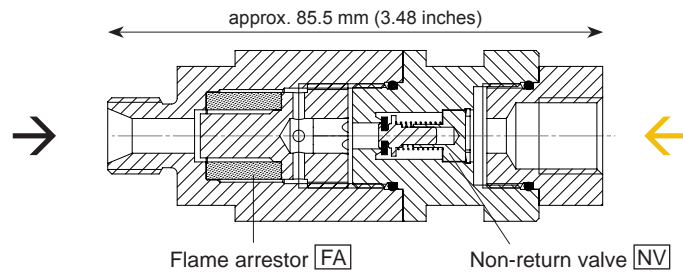

022-015

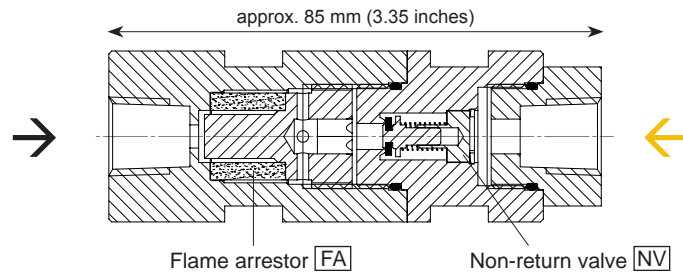

022-014

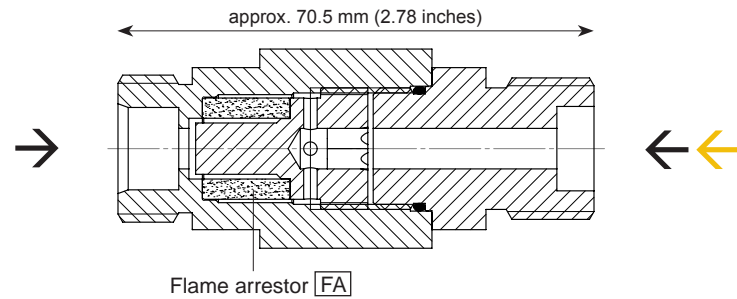

022-002

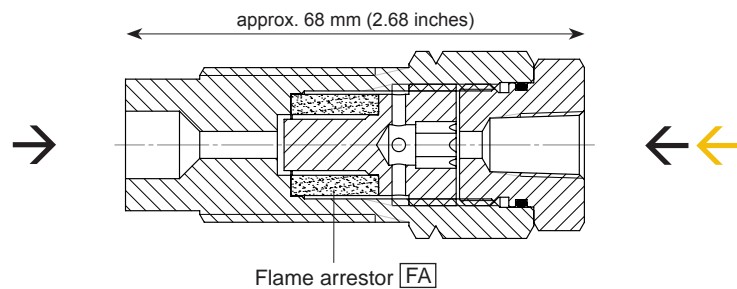

022-013

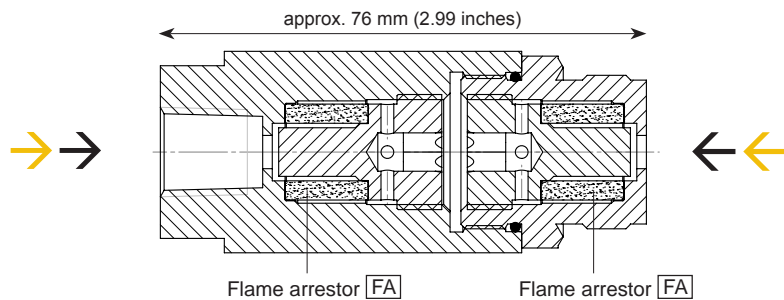

→ flow direction

→ acetylene decomposition (stops C₂H₂ decomposition from this direction)

DECOMPOSITION ARRESTOR MGN

safety device



022-011

Conversion factors:
Acetylene x 1.04

